

GDB 4LC 层门 (地坎宽度=90MM)
Landing Doors Series GDB4LC (Sill Width=90MM)

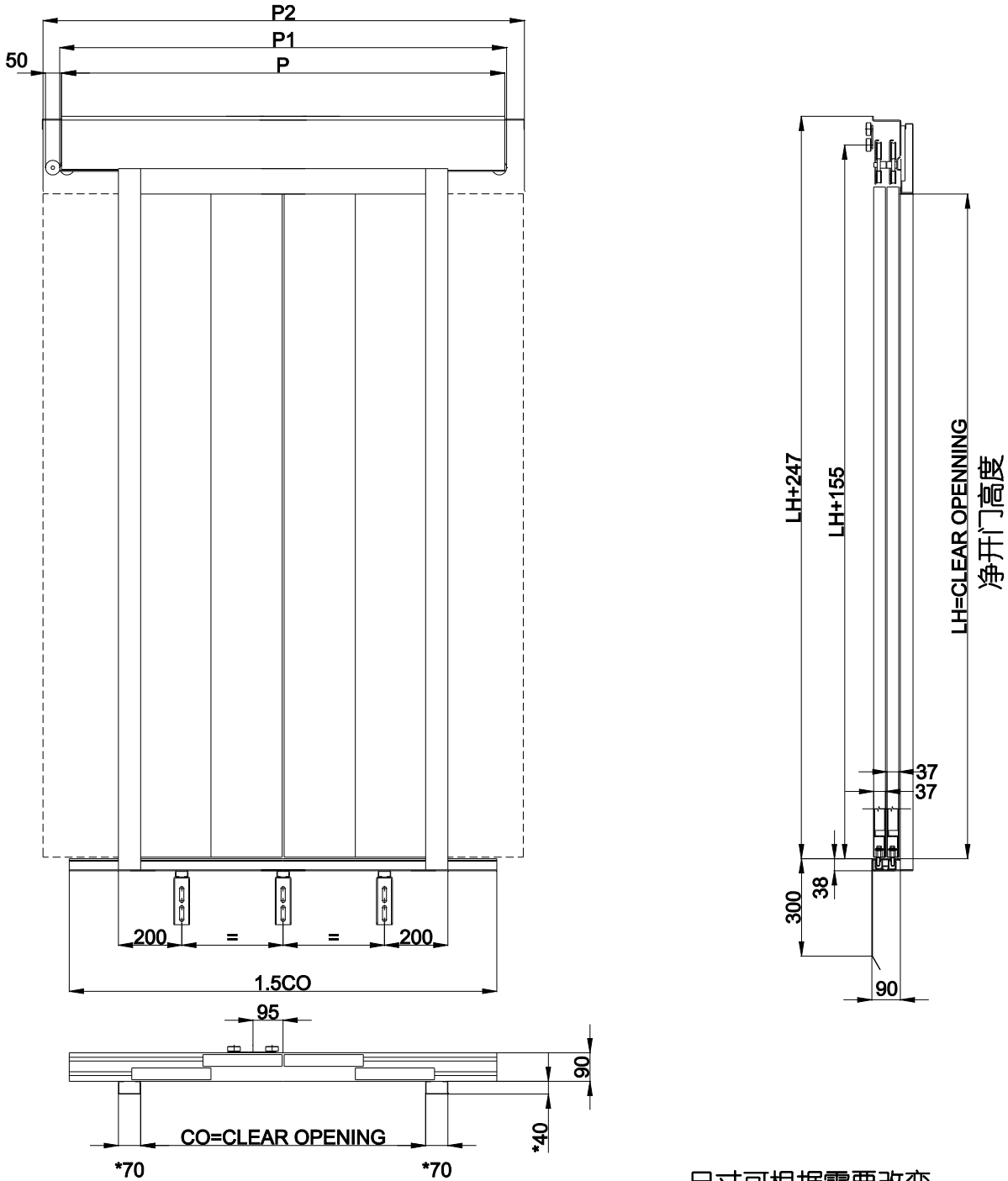

* 尺寸可根据需要改变
DIMENSIONS ARE CHANGEABLE ON REQUEST

CO	700	750	800	850	900	950	1000	1050	1100	1150
P	1150	1200	1250	1375	1425	1475	1575	1625	1675	1725
P1	1165	1215	1265	1390	1440	1490	1590	1640	1690	1740
P2	1100	1175	1250	1325	1400	1475	1550	1625	1700	1775

GDB 4LC 层门 (地坎宽度=90MM)
Landing Doors Series GDB4LC (Sill Width=90MM)

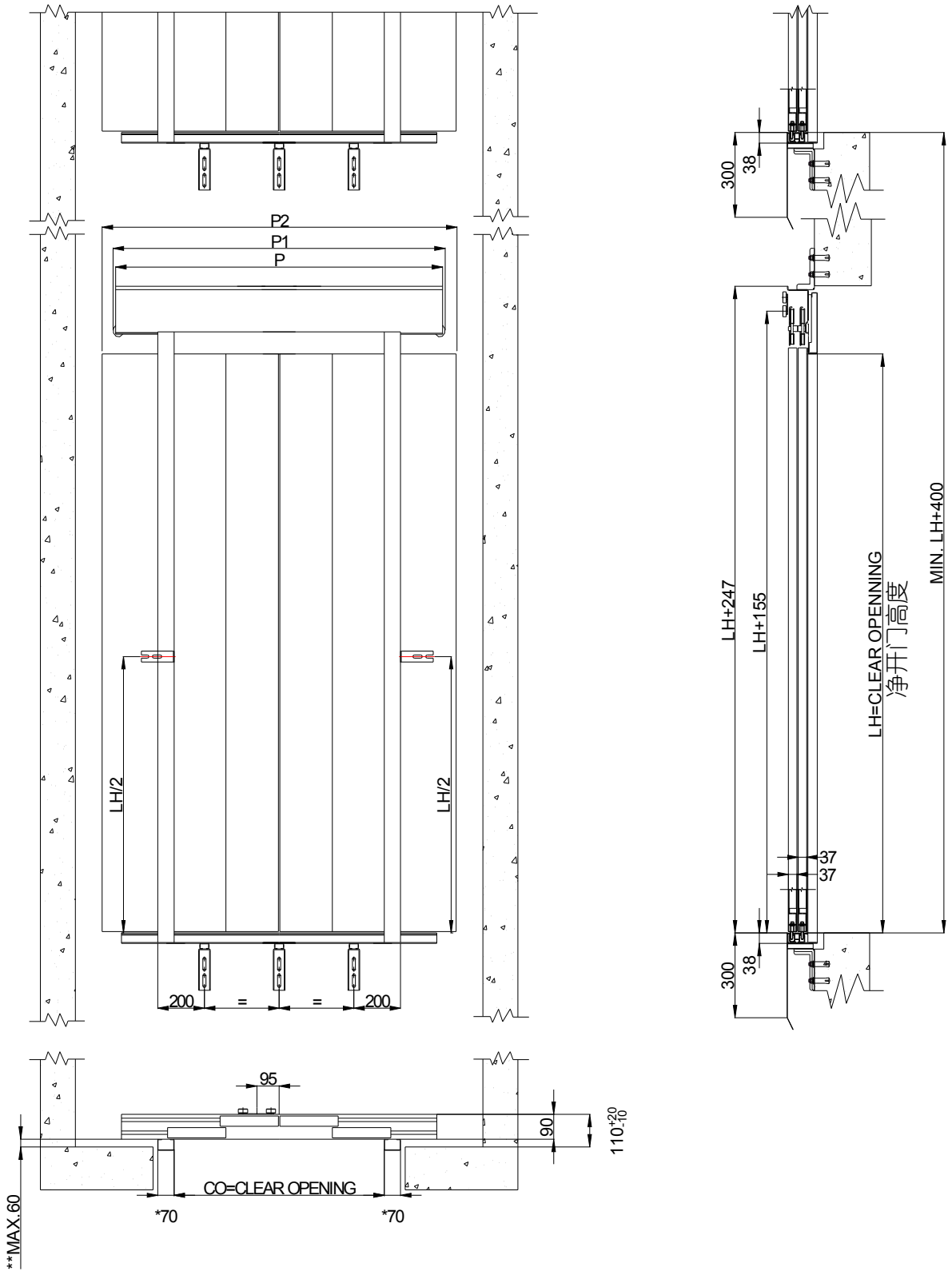

** 可通过更换支架调节到更大尺寸
DIMENSIONS ARE CHANGEABLE BY CHANGE BRACKET

GDB 4LC 层门 (地坎宽度=90MM)
Landing Doors Series GDB 4LC (Sill Width=90MM)

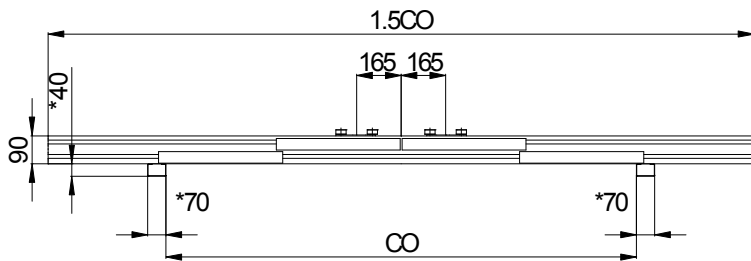
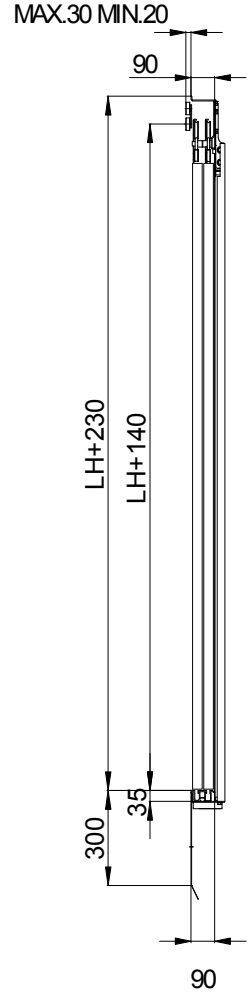
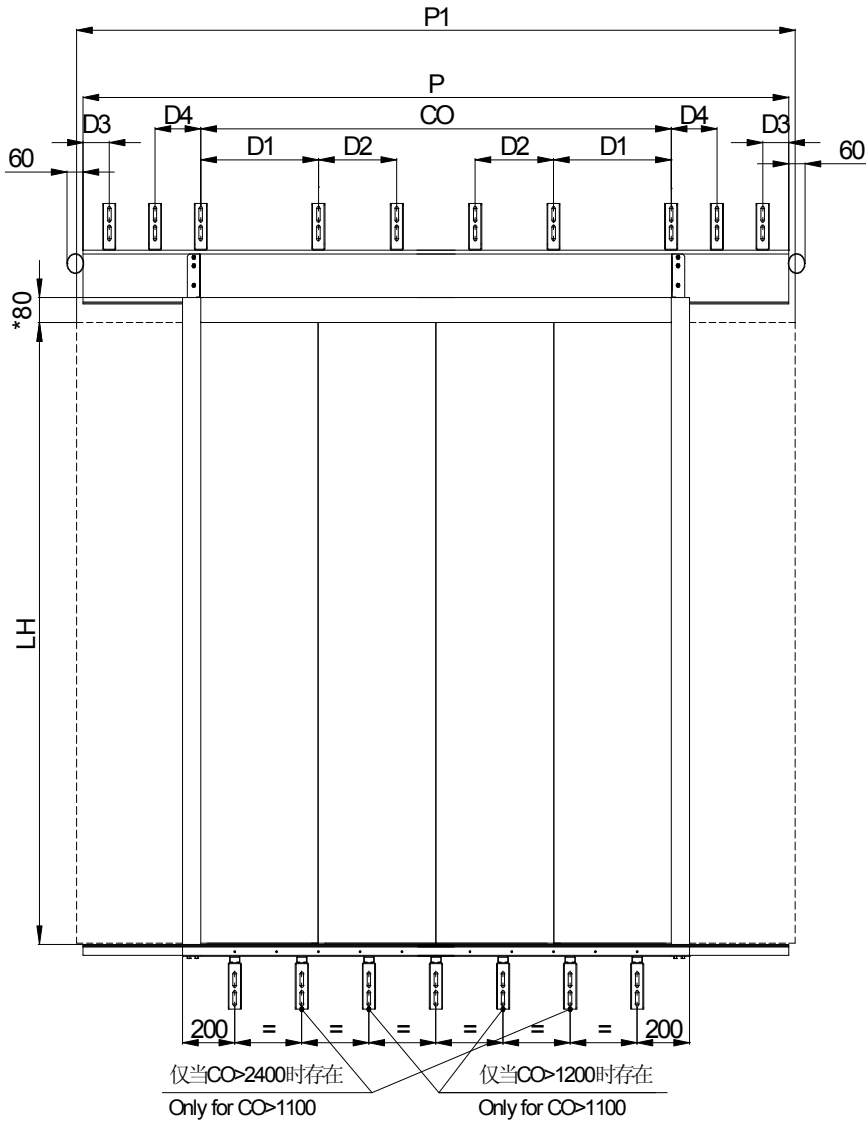

* 尺寸可根据需要改变
DIMENSIONS ARE CHANGEABLE ON REQUEST

CO	1200	1250	1300	1350	1400	1450	1500	1550	1600	1650	1700	1750	1800	1850	1900	1950	2000	2050	2100	2150	2200	2250	2300	2350	2400	2450	2500	2550	2600	2650	2700	2750	2800	2850	2900	2950	3000	3050	3100	3150	3200			
P	1900	1900	1950	2000	2120	2170	2320	2370	2420	2470	2520	2640	2750	2800	2850	2900	3040	3090	3140	3240	3290	3440	3490	3540	3650	3700	3750	3800	3890	3980	4040	4090	4140	4190	4340	4390	4440	4490	4640	4690	4740	4790		
P1	1850	1925	2000	2075	2150	2225	2300	2375	2450	2525	2600	2675	2750	2825	2900	2975	3050	3125	3200	3275	3350	3425	3500	3575	3650	3725	3800	3875	3950	4025	4100	4175	4250	4325	4400	4475	4550	4625	4700	4775	4850			
D1	400	415	430	450	465	480	500	520	535	550	565	580	600	370	380	390	400	410	420	430	440	450	460	470	480	490	500	510	520	530	540	550	560	570	580	590	600	610	620	630	640			
D2	/	/	/	/	/	/	/	/	/	/	/	/	/	370	380	390	400	410	420	430	440	450	460	470	480	490	500	510	520	530	540	550	560	570	580	590	600	610	620	630	640			
D3	/	/	/	/	/	/	100	100	100	100	100	100	100	100	100	100	100	100	100	100	100	100	100	100	100	100	100	100	100	100	100	100	100	100	100	100	100	100	100	100	100	100	100	
D4	/	/	/	/	/	/	/	/	/	/	/	/	/	/	/	/	/	/	/	/	/	/	/	/	/	/	/	/	/	/	/	/	/	/	/	/	/	/	/	/	/	/	/	/

GDB 4LC 层门 (地坎宽度=90MM)
 Landing Doors Series GDB 4LC (Sill Width=90MM)

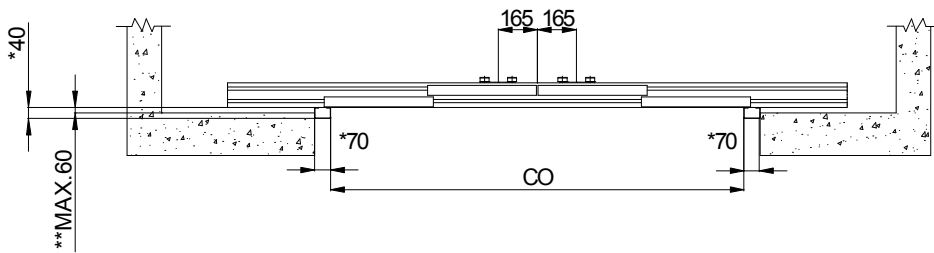
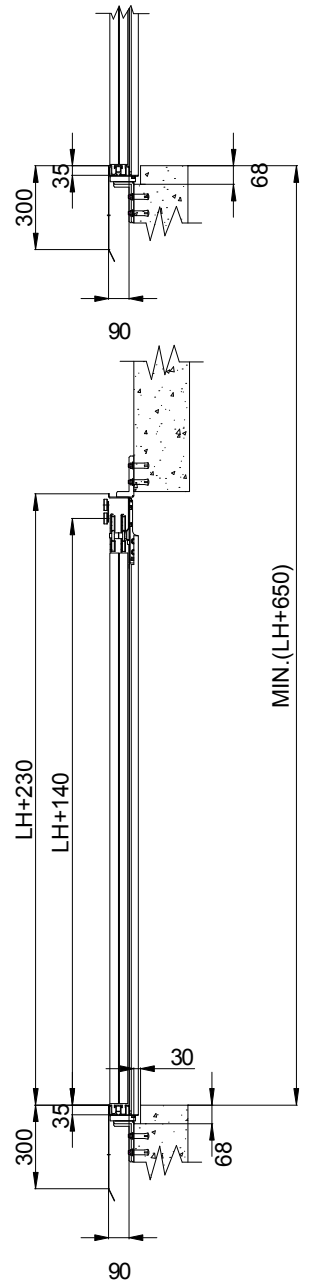
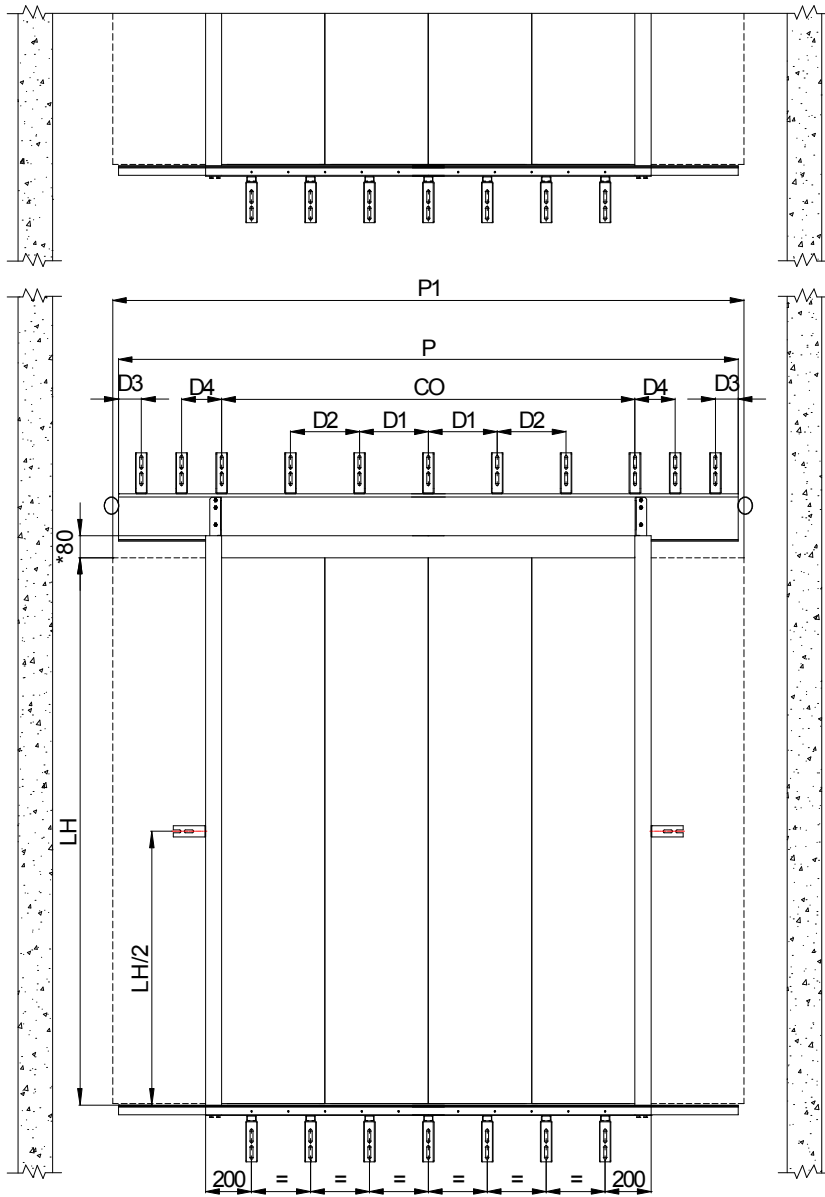

** 可通过更换支架调节到更大尺寸
 DIMENSIONS ARE CHANGEABLE BY CHANGE BRACKET